



# Ampt String Optimizer V1500 Series

Installation Manual

57070012-1 G





Copyright 2018-2020 Ampt, LLC. All rights reserved. No part of this document may be reproduced, retransmitted, or copied in any form without the expressed and written permission of Ampt, LLC.

This document contains information needed to install and commission an Ampt optimizer (including Smart String Technology™ optimizers, String Stretch® optimizers, Ampt Mode® optimizers, String View® optimizers, V-match™ optimizers, I-match™ optimizers, Direct-to-Battery™ optimizers, and Direct-to-Converter™ optimizers) within a photovoltaic (PV) installation. The result? Energy realized®.

All Ampt trademarks are the property of Ampt, LLC. All trademarks are recognized even if they are not marked separately. Visit [www.ampt.com/trademarks](http://www.ampt.com/trademarks) for a list of Ampt trademarks. Any unauthorized use of Ampt trademarks is prohibited. All other trademarks are the property of their respective owners.

U.S. and international patents apply to this product. For details visit: [www.ampt.com/patents](http://www.ampt.com/patents).

## Read This First

To help avoid problems during the system installation, familiarize yourself in advance with the installation process by reading this entire document before starting the installation.



Risk of electric shock, do not remove covers. No user serviceable parts inside. Refer servicing to qualified service personnel. When the photovoltaic array is exposed to light, it supplies a dc voltage to this equipment.



Le risqué de décharge électirque n'enlèvent pas la couverture. Aucunes pieces utiles d'utilisateur à l'intérieur. Référez-vous l'entretien au personnel de service qualifiè. Quand la range photovoltaïque est exposée à la lumière. Il fournit une tension CC à cet équipement.



Hot surfaces – to reduce the risk of burns – do not touch.



Les surfaces chaudes - pour réduire le risque de brûlures - ne se touchent pas.

## IMPORTANT SAFETY INSTRUCTIONS

This manual contains important instructions for Ampt optimizers that shall be followed during installation and maintenance. The optimizer has been designed and tested according to international safety requirements, but requires certain precautions are observed when installing and/or operating the optimizer. To reduce the risk of personal injury and to ensure the safe installation and operation of the optimizer, please be sure you carefully read and follow all instructions and safety messages in this manual.

SAVE THESE INSTRUCTIONS

### Safety Message Types

The following messaging is used to identify a hazard to equipment or personnel:



#### **DANGER**

Indicates a hazardous situation which, if not avoided, will result in death or serious injury.



#### **WARNING**

Indicates a hazardous situation which, if not avoided, could result in death or serious injury.



#### **CAUTION**

Indicates a hazardous situation which, if not avoided, could result in minor or moderate injury.

#### ***NOTICE***

Indicates information considered important but not hazard, or personal injury, related - for example, property damage.

## General Safety

Installation and maintenance should be performed only by qualified persons. Installers and maintenance personnel assume the risk of all injury that might occur during installation or maintenance including, without limitation, the risk of electric shock. Follow your safety procedures and protocols.

All electrical installations must be done in accordance with the local and National Electrical Code ANSI/NFPA 70; Canadian Electrical Code, Part I; or the applicable standards, codes, and regulations for your region.

The Ampt product contains no user-serviceable parts. All repairs and maintenance should be handled in accordance with the instructions and terms contained in the product warranty.

Before installing or using the Ampt optimizer, read all instructions and safety messages on the optimizer and in this manual. Follow the safety precautions for this product as well as the other components in the PV system.

PV modules produce electrical energy when exposed to light and thus can create an electrical shock hazard. Wiring of the PV modules should only be performed by qualified personnel.

## Disclaimer of Liability

Ampt makes no representations, expressed or implied, that with respect to this documentation or any of the equipment and/or software it may describe, including (with no limitation) any implied warranties of utility, merchantability, or fitness for any particular purpose. All such warranties are expressly disclaimed. Ampt shall not be liable for any indirect, incidental, or consequential damages under any circumstances. (The exclusion of implied warranties may not apply in all cases under some statutes, and thus the above exclusion may not apply.)

The following information is subject to change without notice, even though every attempt has been made to make this document complete, accurate and up-to-date. Readers are cautioned, however, that Ampt reserves the right to make changes without notice and shall not be responsible for any damages, including indirect, incidental or consequential damages, caused by reliance on the material presented, including, but not limited to, omissions, typographical errors, arithmetical errors or listing errors in the content material.

### **WARNING**

Any use of the Ampt String Optimizer that is not expressly authorized in this manual or associated documentation is expressly prohibited by Ampt. Ampt disclaims any responsibility or liability for such prohibited use.

# Table of Contents

<b>Read This First .....</b>	<b>3</b>
IMPORTANT SAFETY INSTRUCTIONS.....	4
Safety Message Types.....	4
General Safety.....	5
Disclaimer of Liability.....	6
<b>Chapter 1: Product Overview .....</b>	<b>9</b>
<b>General Description .....</b>	<b>9</b>
<b>Dimensional Drawings .....</b>	<b>11</b>
<b>Physical Overview.....</b>	<b>12</b>
<b>Bar Code Label.....</b>	<b>12</b>
<b>Specifications.....</b>	<b>13</b>
20A Output Models.....	13
16A Output Models.....	14
12A Output Models.....	15
<b>Chapter 2: Planning Installation.....</b>	<b>17</b>
<b>Overview .....</b>	<b>17</b>
<b>Input Criteria .....</b>	<b>17</b>
Acceptable Input Configurations .....	17
Acceptable Input Configurations Between Parallel Optimizers .....	17
<b>PV System Configurations .....</b>	<b>18</b>
Ungrounded PV Systems.....	18
Resistively Grounded PV Systems (positive or negative) .....	18
Fuse Sizes .....	18
DC-coupled Storage .....	19
Inter-row Shading Wiring Example .....	19
<b>Output Connector Polarity .....</b>	<b>20</b>
<b>Chapter 3: Installing the Ampt String Optimizer .....</b>	<b>21</b>
<b>Getting Started .....</b>	<b>21</b>
Parts and Tools Needed .....	21
<b>Mounting and Grounding the String Optimizer .....</b>	<b>22</b>
Steps.....	22
<b>Making Electrical Connections .....</b>	<b>23</b>
Connecting the Inputs.....	24
Connecting the Output .....	27
<b>Uninstalling an Optimizer.....</b>	<b>28</b>
Parts and Tools Needed .....	28
Steps.....	28

<b>Appendix.....</b>	<b>31</b>
<b>Compliance.....</b>	<b>31</b>
Model Numbering System .....	31
Markings.....	32
FCC Compliance.....	33
RSS-GEN .....	33
Avis IC.....	34
RSS-GEN .....	34
<b>Reference: Electrical Connection Order.....</b>	<b>35</b>
<b>Contacts .....</b>	<b>36</b>



# Chapter 1:

## Product Overview

### General Description

Ampt String Optimizers are DC/DC converters with multiple features that lower the cost and improve the performance of new and existing PV systems.

**Dual MPPT per optimizer** - Ampt String Optimizers put maximum power point tracking on each of its two input strings of PV modules. This mitigates or eliminates mismatch losses to deliver more energy under changing environmental and system conditions over the lifetime of the power plant.

**String Stretch**<sup>®</sup> – Ampt's patented String Stretch<sup>®</sup> technology puts voltage and current limits on the output of each optimizer which doubles the number of modules per string and allows for smaller conductor sizing per kilowatt delivered to save up to 50% on electrical BOS costs.

**Ampt Mode**<sup>®</sup> – Inverters with Ampt Mode<sup>®</sup> operate in a narrow input voltage range that is closer to the maximum system voltage. This allows the inverter to deliver a higher AC output voltage at the same current which raises the rated output power of the inverter to lower the inverter's cost per watt.

**V-match**<sup>™</sup> – Ampt's patented V-match<sup>™</sup> technology allows the output of our optimizers to match the DC bus voltage set by the inverter or battery while delivering full available power from the PV modules. This uniquely allows PV arrays with Ampt to automatically adapt to legacy or future power equipment to repower existing systems, upgrade inverters, deploy optimized DC-coupled storage systems, and other applications.

**I-match**<sup>™</sup> - Ampt's patented I-match<sup>™</sup> technology allows the PV array to automatically (or by command) match the desired current of the battery as determined by either the battery SoC or the EMS.

**Direct-to-Converter**<sup>™</sup> – For DC-coupled energy storage systems, Ampt String Optimizers include Direct-to-Converter<sup>™</sup> technology which allows the DC bus to operate at a higher fixed voltage so the converter only needs to buck when charging and boost when discharging. This simplified operation reduces battery converter costs by up to 50% with less circuitry and a higher power density.

**High DC/AC** – Ampt’s unique combination of output current limits and a higher DC bus voltage allows PV system designers to achieve optimal DC/AC ratios (up to 3:1). With Ampt, system owners can expand the DC power on existing systems without replacing inverters, combiners, or cables; optimize inverter utilization on new systems to lower the cost per watt; and lower capex while increasing storage durations on systems with DC-coupled energy storage.

**Wireless Communication** – Ampt String Optimizers incorporate optional wireless communication to provide string-level data that is highly accurate, synchronous, and scalable to improve O&M, as well as enhanced controls for storage applications.

For more information on Ampt’s product features and applications, visit [www.ampt.com](http://www.ampt.com).

# Dimensional Drawings

The dimensions for the String Optimizer shown below are in millimeters and inches.

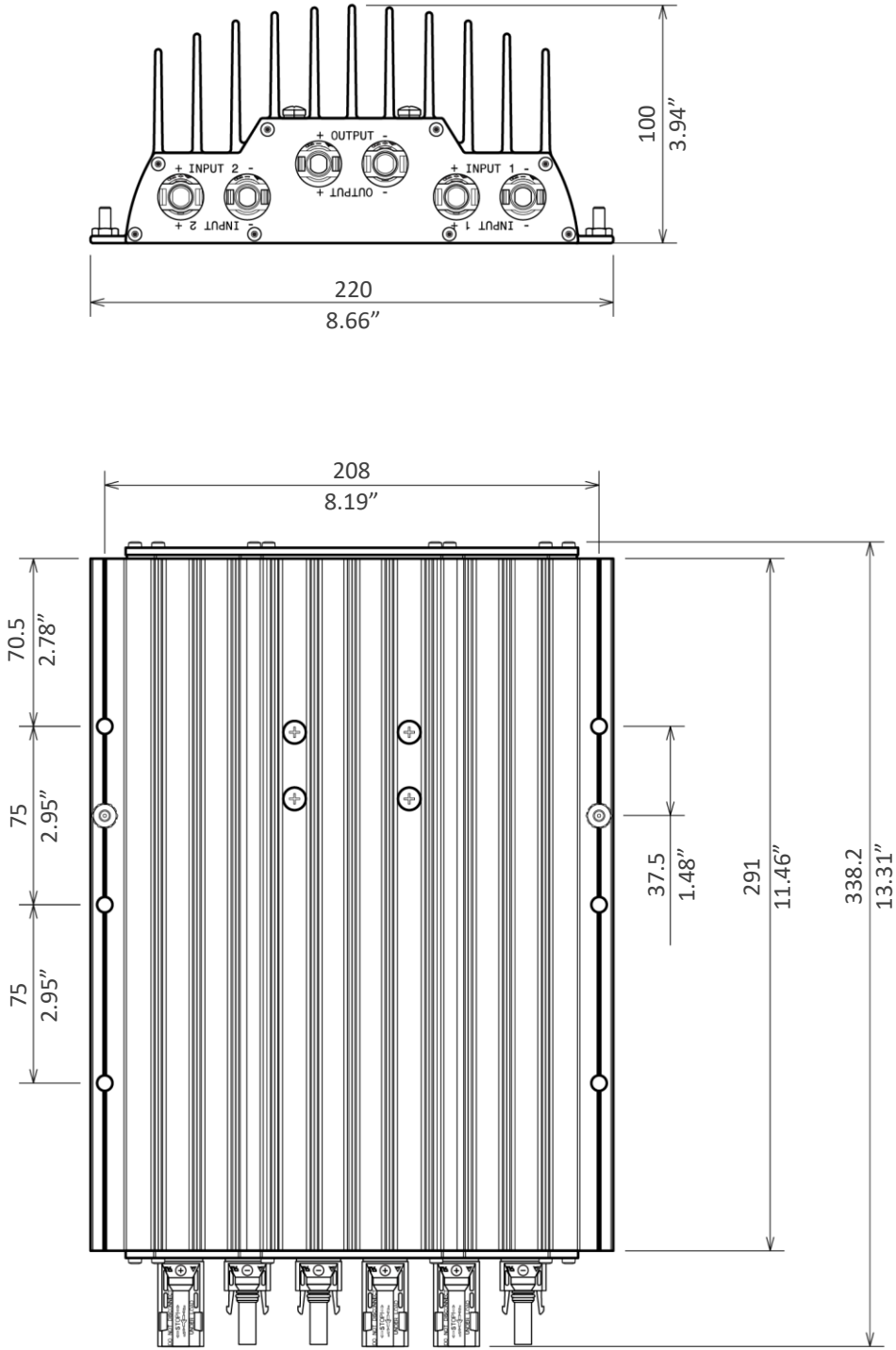

Figure 1: Dimensional drawings

## Physical Overview

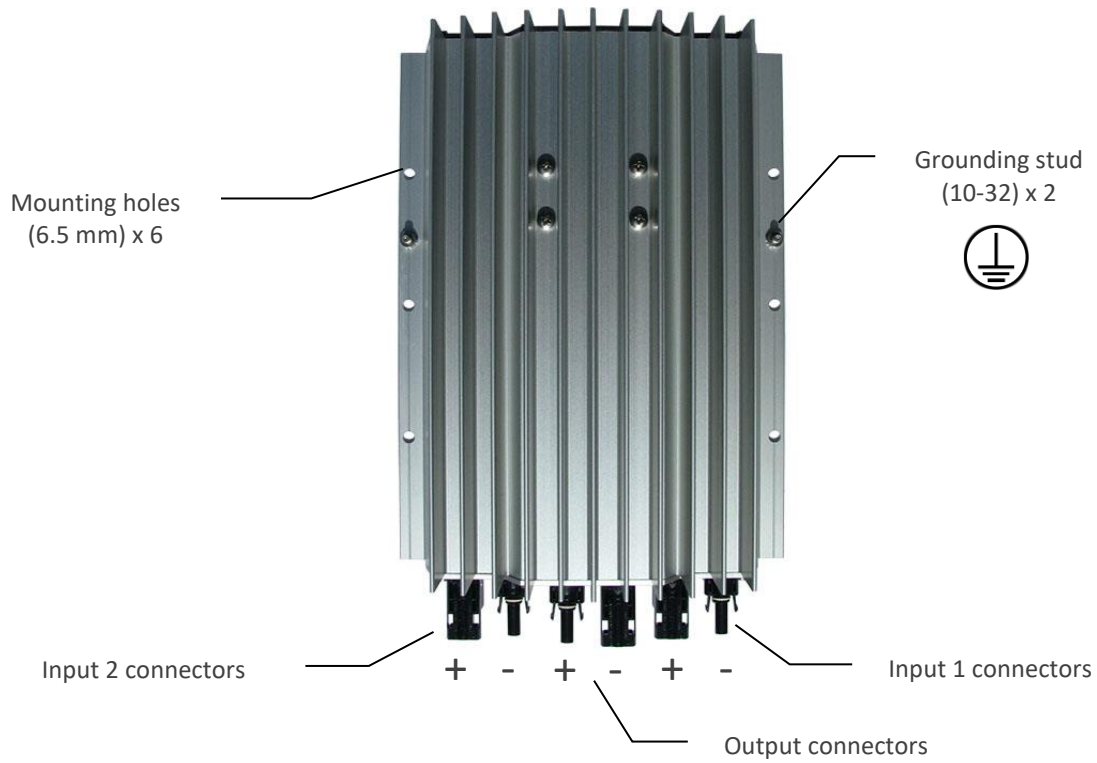

Figure 2: Physical overview of the string optimizer

## Bar Code Label

The image below shows the bar code label with model and serial numbers.

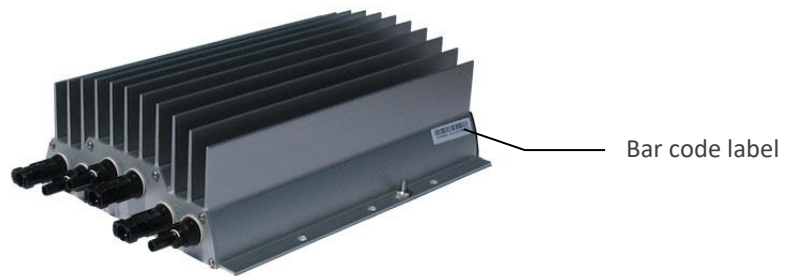

Figure 3: Bar code tag with the model and serial numbers

# Specifications

## 20A Output Models

	V1250-20	V1275-20	V1300-20	V1325-20	V1350-20	V1400-20	V1450-20	V1475-20
Model Number	31570020-1250	31570020-1275	31570020-1300	31570020-1325	31570020-1350	31570020-1400	31570020-1450	31570020-1475
<b>Electrical</b>								
<b>Input</b>								
Maximum voltage per input <sup>1</sup>	V	1500	1500	1500	1500	1500	1500	1500
Maximum current per input <sup>2</sup>	A	12.8	12.8	12.8	12.8	12.8	12.8	12.8
MPP tracking voltage range	V	400-1300	400-1300	400-1300	400-1300	400-1300	400-1300	400-1300
Startup voltage per input	V	510	510	510	510	510	510	510
Number of inputs		2	2	2	2	2	2	2
<b>Output</b>								
Output voltage range	V	0-1250	0-1275	0-1300	0-1325	0-1350	0-1400	0-1475
Maximum output current	A	20	20	20	20	20	20	20
Max continuous output power	kWdc	22.8	23.3	23.8	24.3	24.8	25.8	27.2
Efficiency (max, CEC, Euro)	%	99.6 / 99.5 / 99.4						
<b>Mechanical</b>								
Input & output connector	Amphenol H4							
Dimensions	13.31" x 8.66" x 3.94" (338 mm x 220 mm x 100 mm)							
Weight	11.6 lbs. (5.3 kg)							
Ambient temperature operating range	-40 °F to +122 °F (-40 °C to +50 °C)							
Cooling	Convection							
<b>Environmental</b>								
Environmental category	Outdoor							
Pollution degree	2							
Maximum operating altitude <sup>3</sup>	9843 ft (3000 m)							
Overvoltage category	OVII							
Ingress protection	IP66 / 4X							
<b>General</b>								
Maximum system voltage	1500 V							
Compliance	ETL to UL 1741; IEC 61000-6-1, 61000-6-3, 62109; CE; Giteki 2-1-19; FCC Part 15, class A							

1. Voc at coldest design temp. Follow Ampt's design guidelines to determine the number of modules per input and max. system voltage.

2. Module Imp at standard test condition (STC) - irradiation level of 1000 W/m<sup>2</sup> at 25°C.

3. Optimizer derates above this altitude.

## 16A Output Models

	V1250-16	V1275-16	V1300-16	V1325-16	V1350-16	V1400-16	V1450-16	V1475-16
Model Number	31570021-1250	31570021-1275	31570021-1300	31570021-1325	31570021-1350	31570021-1400	31570021-1450	31570021-1475
<b>Electrical</b>								
<b>Input</b>								
Maximum voltage per input <sup>1</sup>	V	1500	1500	1500	1500	1500	1500	1500
Maximum current per input <sup>2</sup>	A	12.3	12.3	12.3	12.3	12.3	12.3	12.3
MPP tracking voltage range	V	400-1300	400-1300	400-1300	400-1300	400-1300	400-1300	400-1300
Startup voltage per input	V	510	510	510	510	510	510	510
Number of inputs		2	2	2	2	2	2	2
<b>Output</b>								
Output voltage range	V	0-1250	0-1275	0-1300	0-1325	0-1350	0-1400	0-1450
Maximum output current	A	16	16	16	16	16	16	16
Max continuous output power	kWdc	18.5	18.9	19.3	19.7	20.1	20.9	22.0
Efficiency (max, CEC, Euro)	%	99.6 / 99.5 / 99.4						
<b>Mechanical</b>								
Input & output connector	Amphenol H4							
Dimensions	13.31" x 8.66" x 3.94" (338 mm x 220 mm x 100 mm)							
Weight	11.6 lbs. (5.3 kg)							
Ambient temperature operating range	-40 °F to +122 °F (-40 °C to +50 °C)							
Cooling	Convection							
<b>Environmental</b>								
Environmental category	Outdoor							
Pollution degree	2							
Maximum operating altitude <sup>3</sup>	9843 ft (3000 m)							
Overvoltage category	OVII							
Ingress protection	IP66 / 4X							
<b>General</b>								
Maximum system voltage	1500 V							
Compliance	ETL to UL 1741; IEC 61000-6-1, 61000-6-3, 62109; CE; Giteki 2-1-19; FCC Part 15, class A							

1. Voc at coldest design temp. Follow Ampt's design guidelines to determine the number of modules per input and max. system voltage.

2. Module Imp at standard test condition (STC) - irradiation level of 1000 W/m<sup>2</sup> at 25°C.

3. Optimizer derates above this altitude.

## 12A Output Models

	V1325-12	V1350-12	V1400-12	V1450-12	V1475-12	
Model Number	31570022-1325	31570022-1350	31570022-1400	31570022-1450	31570022-1475	
<b>Electrical</b>						
<b>Input</b>						
Maximum voltage per input <sup>1</sup>	V	1500	1500	1500	1500	
Maximum current per input <sup>2</sup>	A	12.3	12.3	12.3	12.3	
MPP tracking voltage range	V	400-1300	400-1300	400-1300	400-1300	
Startup voltage per input	V	510	510	510	510	
Number of inputs		2	2	2	2	
<b>Output</b>						
Output voltage range	V	0-1325	0-1350	0-1400	0-1450	0-1475
Maximum output current	A	12	12	12	12	12
Max continuous output power	kWdc	14.9	15.2	15.8	16.4	16.7
Efficiency (max, CEC, Euro)	%	99.6 / 99.5 / 99.4				
<b>Mechanical</b>						
Input & output connector	Amphenol H4					
Dimensions	13.31" x 8.66" x 3.94" (338 mm x 220 mm x 100 mm)					
Weight	11.6 lbs. (5.3 kg)					
Ambient temperature operating range	-40 °F to +122 °F (-40 °C to +50 °C)					
Cooling	Convection					
<b>Environmental</b>						
Environmental category	Outdoor					
Pollution degree	2					
Maximum operating altitude <sup>3</sup>	9843 ft (3000 m)					
Overvoltage category	OVII					
Ingress protection	IP66 / 4X					
<b>General</b>						
Maximum system voltage	1500 V					
Compliance	ETL to UL 1741; IEC 61000-6-1, 61000-6-3, 62109; CE; Giteki 2-1-19; FCC Part 15, class A					

1. Voc at coldest design temp. Follow Ampt's design guidelines to determine the number of modules per input and max. system voltage.

2. Module Imp at standard test condition (STC) - irradiation level of 1000 W/m<sup>2</sup> at 25°C.

3. Optimizer derates above this altitude.





# Chapter 2:

## Planning Installation

### Overview

This chapter defines the acceptable criteria for input connections, describes the appropriate electrical connections based on the grounding configuration of your PV system, and explains the mating connector polarities for the inputs and output of the String Optimizer.

### Input Criteria

This section defines the acceptable criteria for the two input connections of the Ampt String Optimizer.

**NOTICE**

The inputs of the optimizer are not intended for connection to a battery or any other type of DC source except PV modules.

The following information applies to 60- or 72-cell c-Si/p-Si modules. If you are using another type of module (e.g. thin film), please contact Ampt for configuration rules.

### Acceptable Input Configurations

It is common for inputs 1 and 2 to have the same number of modules (i.e.  $I_{n1} = I_{n2}$ ). However, if the number of modules between inputs is different, the following conditions must be met for the optimizer to operate at MPP.

$$V_{oc-cold-in1} \geq V_{oc-cold-in2}$$

$$V_{out}/2 < V_{mpp-in1} < V_{out}$$

$$V_{oc-cold-in1} \leq 1500V$$

$$V_{out}/2 < V_{mpp-in2} < V_{out}$$

$$V_{oc-cold-in1} \leq \text{Inverter maximum input voltage}$$

$$0.5 \times P_{in1} < P_{in2} < P_{in1}$$

### Acceptable Input Configurations Between Parallel Optimizers

The number of modules on each input between parallel optimizers can vary within an array so long as they meet the criteria described in the *Acceptable Input Configurations* section.

## PV System Configurations

String Optimizers can be installed in ungrounded and resistively grounded PV systems.

### Ungrounded PV Systems

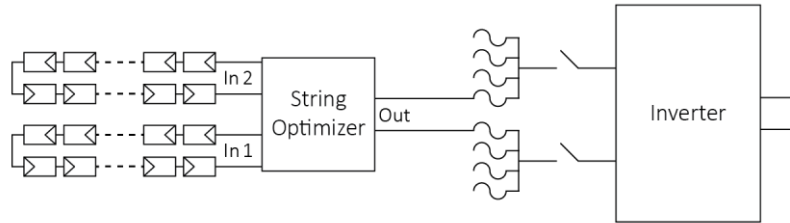

Figure 4: Electrical connections for an ungrounded PV system

### Resistively Grounded PV Systems (positive or negative)

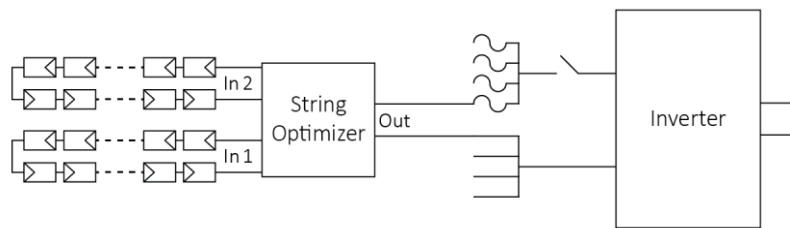

Figure 5: Electrical connections for a grounded PV system

### Fuse Sizes



#### CAUTION

Over-current protection devices and conductors shall be sized in accordance with the National Electrical Code (ANSI/NFPA 70); Canadian Electrical Code, Part I; or the applicable standards, codes, and regulations for your region.

The output current limit of the Ampt String Optimizer eliminates the need for the 1.25 multiplication factor for over-sun conditions when calculating ampacity. The 1.25 multiplier for continuous use is still required.

Optimizer Max Output Current (A)	Minimum Fuse Size (A)
12	15
16	20
20	25

## DC-coupled Storage

When used in DC-coupled storage applications, the optimizer does not function as a blocking diode.

## Inter-row Shading Wiring Example

When inter-row shading is expected, the best practice is to wire the modules on the two inputs of the Ampt String Optimizer to be on the same row as shown below.

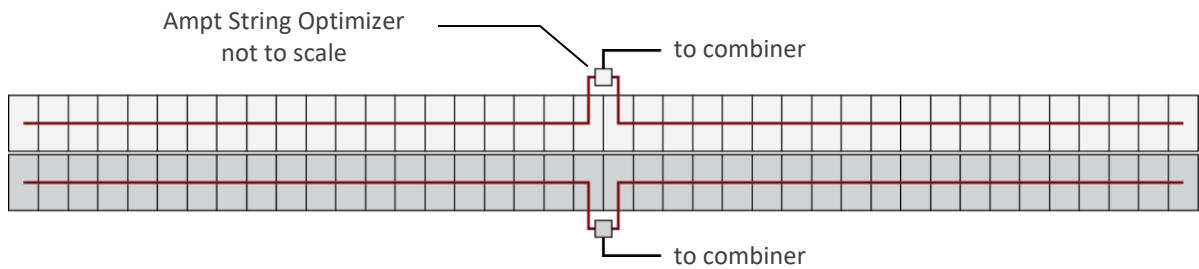
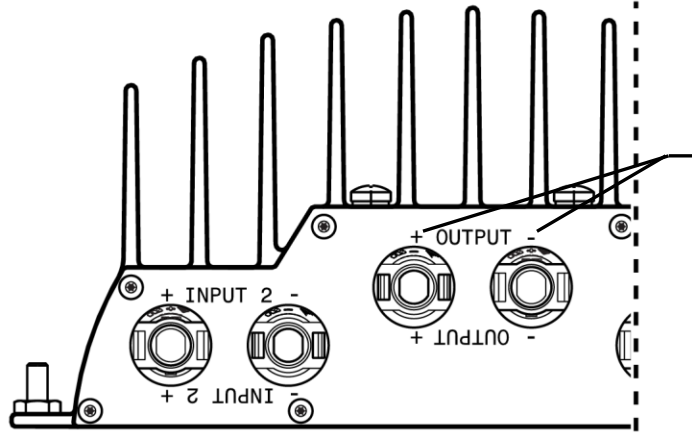

Figure 6: Wiring example when inter-row shading is expected

# Output Connector Polarity

The optimizers have Amphenol H4 bulkhead connectors. Use the polarity markings on the faceplate instead of the polarity markings on the connectors.

Optimizer  
Front View



! Use the polarity markings on the faceplate

Optimizer  
Top View

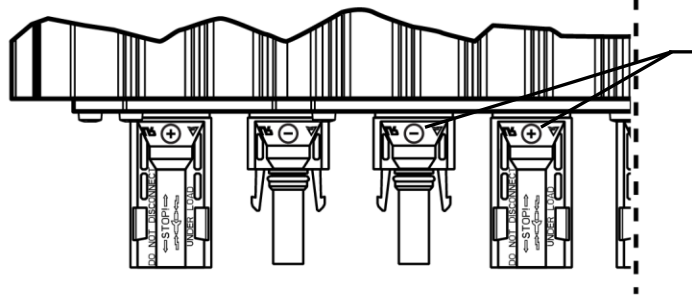

⊘ Ignore polarity markings on the bulkhead connectors on the output

Output Mating  
Connectors  
Top View

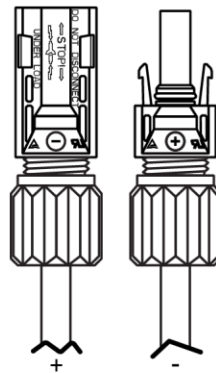

Figure 7: Output connector polarity

# Chapter 3:

## Installing the Ampt String Optimizer

### Getting Started

This chapter addresses the proper mounting and installation of the Ampt String Optimizer. Read the entire chapter before starting the procedures and then conduct each task in the order given.

### Parts and Tools Needed

- The mounting hardware varies by the type of PV module mounting rail.
- Voltmeter (rated for the PV system's maximum system voltage) with DC current clamp.
- Amphenol Sealing Caps – H4 or UTX



H4 Sealing Cap (for female)  
H4PF



UTX Sealing Cap (for female)  
UTXF



H4 Sealing Cap (for male)  
H4PM



UTX Sealing Cap (for male)  
UTXM

## Mounting and Grounding the String Optimizer

### WARNING

Read the warning statements below:

Installation and maintenance should be performed only by qualified persons. Installers and maintenance personnel assume the risk of all injury that might occur during installation or maintenance including, without limitation, the risk of electric shock. Follow your safety procedures and protocols.

All electrical installations must be done in accordance with the local and National Electrical Code ANSI/NFPA 70; Canadian Electrical Code, Part I; or the applicable standards, codes, and regulations for your region.

The Ampt optimizer is to be installed so that it is not expected to be contacted by persons.

### CAUTION

Keep connectors dry and clean. Do not install Ampt String Optimizers in a location where they might be immersed in water.

## Steps

1. Mount the String Optimizer to the rack using the mounting holes provided.
  - a. See *Dimensional Drawings* on page 11
  - b. The recommended practice is to mount the unit parallel to the PV modules with the connectors facing downward.
  - c. Ensure sufficient spacing such that the safety icons as well as the serial and model numbers on the bar code label can be read by maintenance personnel.
2. Ground the String Optimizer as required by your local codes using one of the grounding studs provided, or with a listed bonding washer.

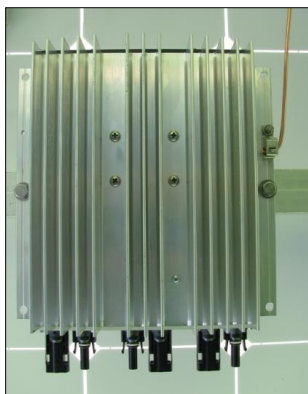

Figure 8: Ampt String Optimizer mounted and grounded

## Making Electrical Connections

### **WARNING**

Read the warning statements below:

Installation and maintenance should be performed only by qualified persons. Installers and maintenance personnel assume the risk of all injury that might occur during installation or maintenance including, without limitation, the risk of electric shock. Follow your safety procedures and protocols.

Do not make or break connections under load.

Ensure that there are no parallel connections to the string while series connections are being made.

Voltage may be present on the output terminals when an input terminal is connected.

Voltage builds as modules are connected in series.

### **CAUTION**

Read the caution statements below:

To reduce the risk of fire, connect the outputs of the Ampt equipment only to conductors with sufficient ampacity based on the maximum output fault current (maximum optimizer output current) for the chosen optimizer. Over-current protection devices and conductors shall be sized in accordance with the National Electrical Code (ANSI/NFPA 70); Canadian Electrical Code, Part I; or the applicable standards, codes, and regulations for your region.

Over current protection is required for the DC output circuit in the installation.

Ampt recommends that a disconnect switch be included in the installation for the DC output.

### **NOTICE**

Use only Amphenol H4 mating connectors.

### NOTICE

Per Canadian Electrical Code, the installer is required to mark the device with the following wording or equivalent, located on or adjacent to each wiring compartment giving access to high voltage circuits, only if actually connected to high voltage in the installation:

DANGER — HIGH VOLTAGE

or

DANGER XXX V

where XXX is replaced by the rated voltage.

### Connecting the Inputs

1. Read the warning, caution, and notice statements starting on page 23.
2. Make sure you are familiar with all sections in Chapter 2 and that the unit is properly mounted and grounded.
3. Make sure the strings of PV modules that will be connected to the inputs of the optimizer meet the acceptable criteria outlined in the *Input Criteria* section on page 17.
4. Follow your safety procedures and protocols to connect the PV modules in series for each input.
5. Follow your safety procedures and protocols to measure the voltage and verify the polarity for the string of modules being connected to Input 1.

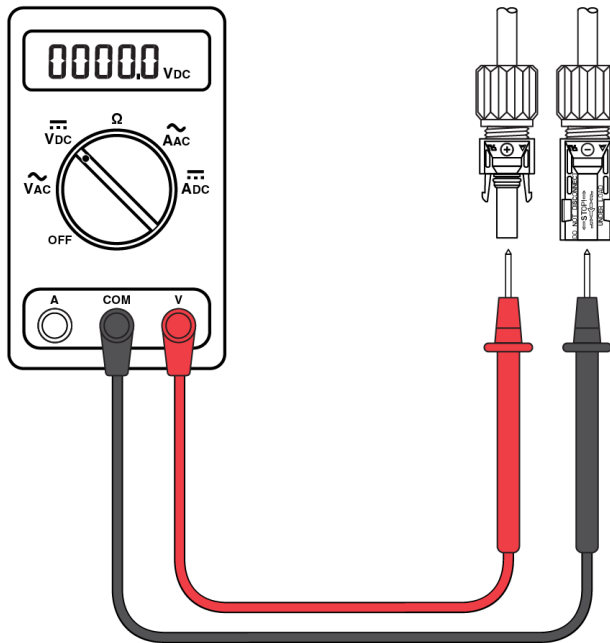

Figure 9: Check the polarity and gender for PV string



6. Connect the series of modules for Input 1 to the String Optimizer. Ensure that the locking mechanisms on the connectors are fully engaged.

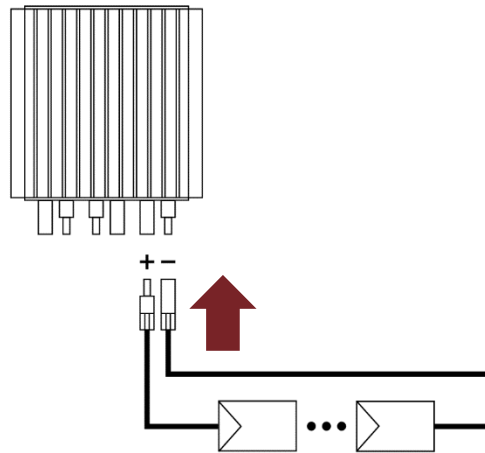

Figure 10: Connecting Input 1

7. Follow your procedures and safety protocols to measure the voltage and verify the polarity for the string of modules being connected to Input 2. See Figure 9.
8. Connect the series of modules for Input 2 to the String Optimizer. Ensure that the locking mechanisms on the connectors are fully engaged.

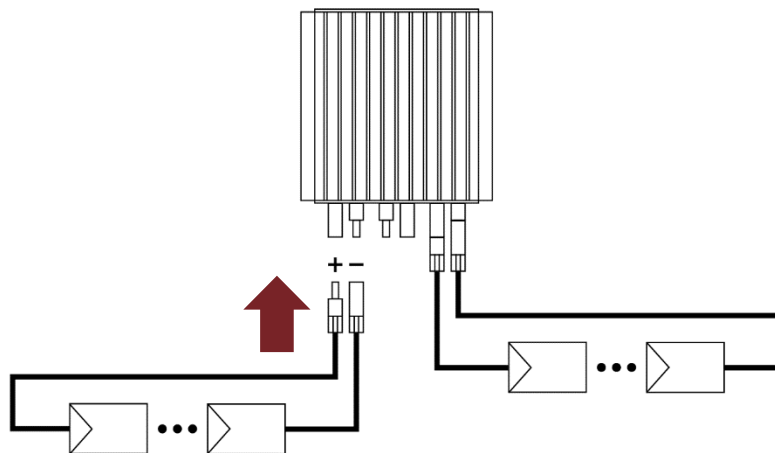

Figure 11: Connecting Input 2

- Follow your safety procedures and protocols to measure the output voltage of the String Optimizer. It should be equal to the maximum value of the Output Voltage Range on the product label (+/- 15 volts). If it is not, contact Ampt.

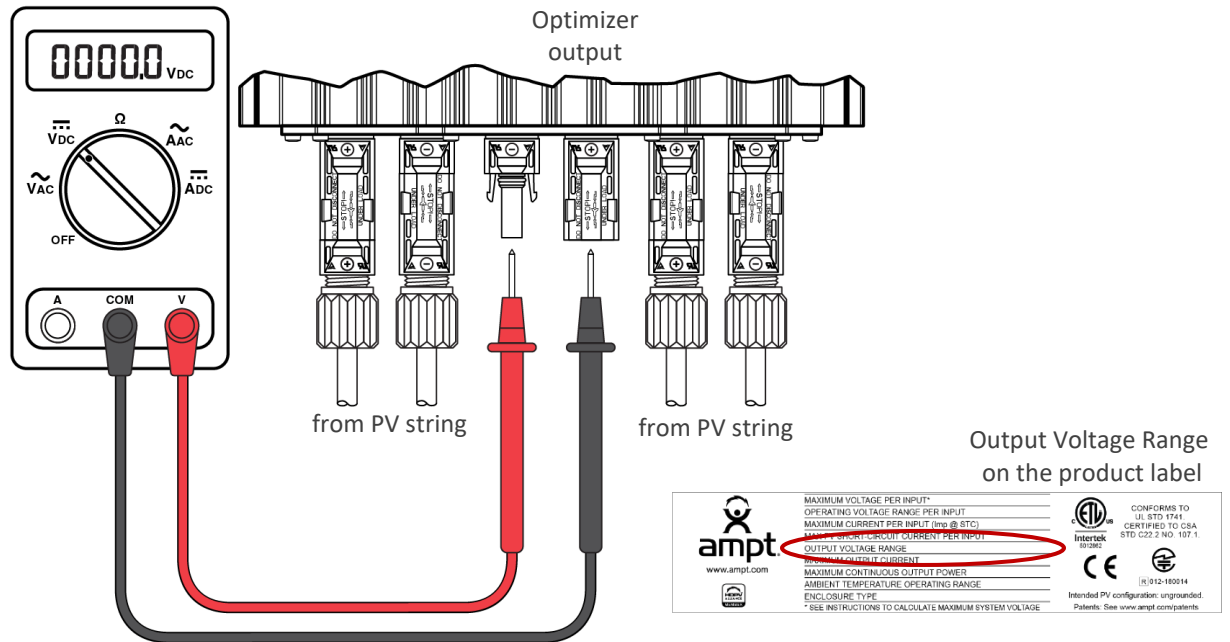

Figure 12: Verify proper installation

- If you are connecting the output now, then proceed to the next section. Otherwise, use Amphenol Sealing Caps to protect the connectors until the output is connected.

## Connecting the Output

1. Read the warning, caution, and notice statements starting on page 23.
2. Make sure you have completed all the steps in the *Connecting the Inputs* section starting on page 24.
3. Follow your safety procedures and protocols to ensure the output cables are appropriately terminated and not under load.
4. Connect the appropriate cables to the output of the String Optimizer.

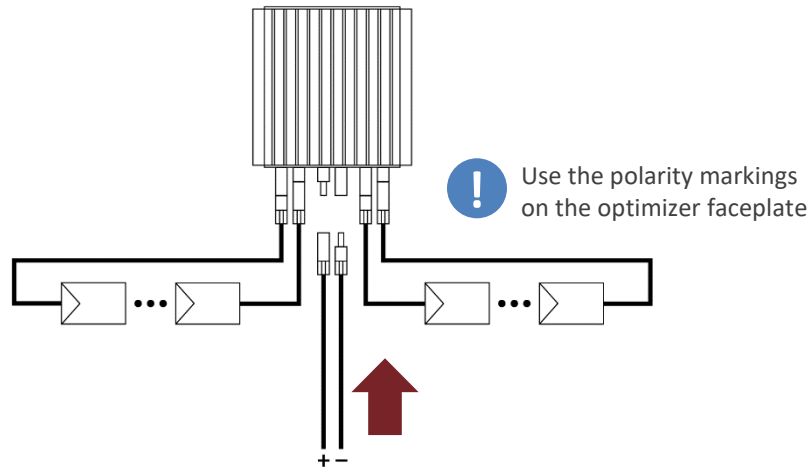

Figure 13: Connecting the output connectors

5. Ensure that the locking mechanisms on all connectors are fully engaged.

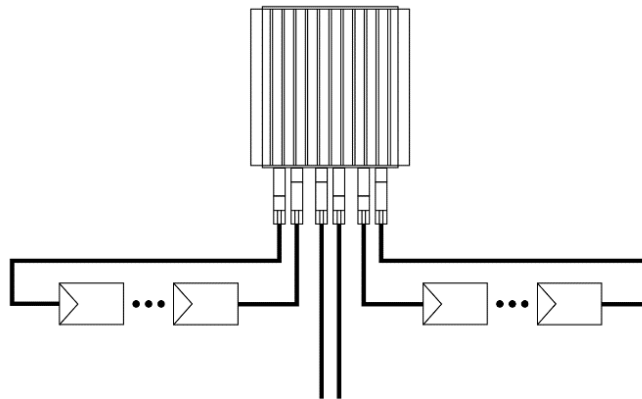

Figure 14: Verify that the connectors are fully engaged

## Uninstalling an Optimizer

### WARNING

Read the warning statements below:

Installation and maintenance should be performed only by qualified persons. Installers and maintenance personnel assume the risk of all injury that might occur during installation or maintenance including, without limitation, the risk of electric shock. Follow your safety procedures and protocols.

Do not perform any servicing other than that specified in these instructions.

Do not make or break connections under load.

Voltage may be present on the output terminals when an input terminal is connected.

### CAUTION

Read that caution statements below:

The Ampt product contains no user-serviceable parts. All repairs and maintenance should be handled in accordance with the instructions and terms contained in the product warranty.

The surface of the optimizer may be hot.

## Parts and Tools Needed

- One of the following Amphenol connector unlocking tools.



H4 Universal unlocking tool  
H4TU0000



H4 Wrench Tool  
H4TW0001



UTX Wrench Tool  
UTXTWA001

## Steps

1. Read the warning and caution statements above.
2. Follow your safety procedures and protocols to ensure the String Optimizer is not under load.
3. Follow your safety procedures and protocols to verify that there is zero current flowing through the optimizer circuit by using a current clamp to test each wire connected to Input 1, Input 2, and the output.
  - a. If current is detected on any of these cables, wait for zero irradiance and verify that there is zero current flowing through the optimizer circuit.

4. If no current is detected, then use the Amphenol H4 connector unlocking tool to disconnect connectors in the following order:
  - a. Output
  - b. Input 1
  - c. Input 2



# Appendix

## Compliance

\*\*\*

The box is not meant to be user serviced or opened in any way.

\*\*\*





## Model Numbering System

The model numbers for Ampt String Optimizers are in the following format:

- 31570020-xxxx (20A models, ranging from 400 – 1500V)
- 31570021-xxxx (16A models, ranging from 400 – 1500V)
- 31570022-xxxx (12A models, ranging from 400 – 1500V)

...where xxxx equals voltage of the unit (e.g. -0750 is a V750; -1325 is V1325).

## Markings

 www.ampt.com	MAXIMUM VOLTAGE PER INPUT*	 CONFORMS TO UL STD 1741. CERTIFIED TO CSA STD C22.2 NO. 107.1.
	OPERATING VOLTAGE RANGE PER INPUT	
	MAXIMUM CURRENT PER INPUT (Imp @ STC)	
	MAX PV SHORT-CIRCUIT CURRENT PER INPUT	
	OUTPUT VOLTAGE RANGE	
	MAXIMUM OUTPUT CURRENT	
	MAXIMUM CONTINUOUS OUTPUT POWER	
	AMBIENT TEMPERATURE OPERATING RANGE	
	ENCLOSURE TYPE	
	* SEE INSTRUCTIONS TO CALCULATE MAXIMUM SYSTEM VOLTAGE	
  Intended PV configuration: ungrounded. Patents: See www.ampt.com/patents		

## 20A Models

	V1250-20	V1275-20	V1300-20	V1325-20	V1350-20	V1400-20	V1450-20	V1475-20
Ampt model number	31570020-1250	31570020-1275	31570020-1300	31570020-1325	31570020-1350	31570020-1400	31570020-1450	31570020-1475
Maximum voltage per input (Vdc)	1500	1500	1500	1500	1500	1500	1500	1500
Operating voltage range per input (Vdc)	400 – 1300	400 – 1300	400 – 1300	400 – 1300	400 – 1300	400 – 1300	400 – 1300	400 – 1300
Maximum current per input (Imp@STC) (A dc)	12.8	12.8	12.8	12.8	12.8	12.8	12.8	12.8
Max PV short-circuit current per input (A dc)	13.3	13.3	13.3	13.3	13.3	13.3	13.3	13.3
Output voltage range (Vdc)	0-1250	0-1275	0-1300	0-1325	0-1350	0-1400	0-1450	0-1475
Maximum output current (A dc)	20	20	20	20	20	20	20	20
Maximum continuous output power (kWdc)	22.8	23.3	23.8	24.3	24.8	25.8	26.7	27.2
Ambient temperature operating range	-40°C - 50°C	-40°C - 50°C	-40°C - 50°C	-40°C - 50°C	-40°C - 50°C	-40°C - 50°C	-40°C - 50°C	-40°C - 50°C
Enclosure type	IP 66/4X	IP 66/4X	IP 66/4X	IP 66/4X	IP 66/4X	IP 66/4X	IP 66/4X	IP 66/4X

## 16A Models

	V1250-16	V1275-16	V1300-16	V1325-16	V1350-16	V1400-16	V1450-16	V1475-16
Ampt model number	31570021-1250	31570021-1275	31570021-1300	31570021-1325	31570021-1350	31570021-1400	31570021-1450	31570021-1475
Maximum voltage per input (Vdc)	1500	1500	1500	1500	1500	1500	1500	1500
Operating voltage range per input (Vdc)	400 – 1300	400 – 1300	400 – 1300	400 – 1300	400 – 1300	400 – 1300	400 – 1300	400 – 1300
Maximum current per input (Imp@STC) (A dc)	12.3	12.3	12.3	12.3	12.3	12.3	12.3	12.3
Max PV short-circuit current per input (A dc)	13.3	13.3	13.3	13.3	13.3	13.3	13.3	13.3
Output voltage range (Vdc)	0-1250	0-1275	0-1300	0-1325	0-1350	0-1400	0-1450	0-1475
Maximum output current (A dc)	16	16	16	16	16	16	16	16
Maximum continuous output power (kWdc)	18.5	18.9	19.3	19.7	20.1	20.9	21.6	22.0
Ambient temperature operating range	-40°C - 50°C	-40°C - 50°C	-40°C - 50°C	-40°C - 50°C	-40°C - 50°C	-40°C - 50°C	-40°C - 50°C	-40°C - 50°C
Enclosure type	IP 66/4X	IP 66/4X	IP 66/4X	IP 66/4X	IP 66/4X	IP 66/4X	IP 66/4X	IP 66/4X



## 12A Models

	V1325-12	V1350-12	V1400-12	V1450-12	V1475-12
Ampt model number	31570022-1325	31570022-1350	31570022-1400	31570022-1450	31570022-1475
Maximum voltage per input (Vdc)	1500	1500	1500	1500	1500
Operating voltage range per input (Vdc)	400 – 1300	400 – 1300	400 – 1300	400 – 1300	400 – 1300
Maximum current per input (Imp@STC) (Adc)	12.3	12.3	12.3	12.3	12.3
Max PV short-circuit current per input (Adc)	13.3	13.3	13.3	13.3	13.3
Output voltage range (Vdc)	0-1325	0-1350	0-1400	0-1450	0-1475
Maximum output current (Adc)	12	12	12	12	12
Maximum continuous output power (kWdc)	14.9	15.2	15.8	16.4	16.7
Ambient temperature operating range	-40°C - 50°C	-40°C - 50°C	-40°C - 50°C	-40°C - 50°C	-40°C - 50°C
Enclosure type	IP 66/4X	IP 66/4X	IP 66/4X	IP 66/4X	IP 66/4X

## FCC Compliance

This device complies with part 15 of the FCC Rules. Operation is subject to the following two conditions: (1) This device may not cause harmful interference, and (2) this device must accept any interference received, including interference that may cause undesired operation.

**IMPORTANT!** Changes or modifications not expressly approved by Ampt, LLC could void the user's authority to operate the equipment.

Model: 1500V  
 FCC ID: X3R-1500V  
 IC: 8399A-1500V

\*\*\*

## RSS-GEN

This device contains license-exempt transmitter(s)/receiver(s) that comply with Innovation, Science and Economic Development Canada's license-exempt RSS(s). Operation is subject to the following two conditions:

1. This device may not cause interference.
2. This device must accept any interference, including interference that may cause undesired operation of the device.

## Avis IC

Cet appareil est conforme à la partie 15 des règles de la FCC. Son fonctionnement est soumis aux deux conditions suivantes: (1) Ce dispositif ne peut causer des interférences nuisibles, et (2) cet appareil doit accepter toute interférence reçue, y compris les interférences qui peuvent provoquer un fonctionnement indésirable.

IMPORTANT! Les changements ou modifications non expressément approuvés par Ampt, LLC pourraient annuler l'autorité de l'utilisateur à utiliser l'équipement.

Model: 1500V  
FCC ID: X3R-1500V  
IC: 8399A-1500V

\*\*\*

## RSS-GEN

L'émetteur/récepteur exempt de licence contenu dans le présent appareil est conforme aux CNR d'Innovation, Sciences et Développement économique Canada applicables aux appareils radio exempts de licence. L'exploitation est autorisée aux deux conditions suivantes:

1. L'appareil ne doit pas produire de brouillage.
2. L'appareil doit accepter tout brouillage radioélectrique subi, même si le brouillage est susceptible d'en compromettre le fonctionnement.

## Reference: Electrical Connection Order

After the installer has read the manual, this page can be used as a reference on the job site to recall the electrical connection order and avoid damage to the device.



These instructions are for reference only and do not replace the installation manual. See the manual for complete instructions and safety messages.



### WARNING

Read the warning statements below:

Installation and maintenance should be performed only by qualified persons. Installers and maintenance personnel assume the risk of all injury that might occur during installation or maintenance including, without limitation, the risk of electric shock. Follow your safety procedures and protocols.

Do not make or break connections under load.

Ensure that there are no parallel connections to the string while series connections are being made.

Voltage may be present on the output terminals when an input terminal is connected.

Voltage builds as modules are connected in series.

### NOTICE

Failure to follow the prescribed connection order can result in damage to the device.

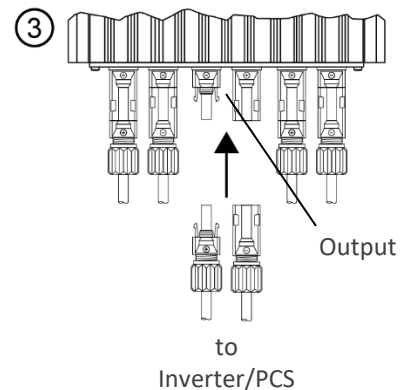
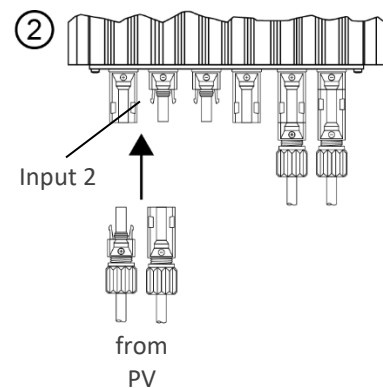
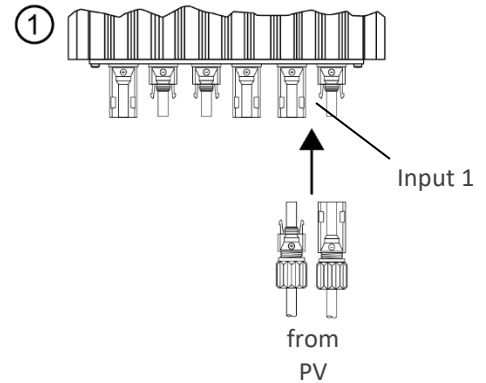

## Contacts

### Headquarters

Ampt, LLC  
4850 Innovation Drive  
Fort Collins, CO 80525  
970-372-6950

### Sales

Global: sales@ampt.com

North America: p: +1 970.372.6952  
f: +1 970.225.0483

Europe: p: +49 7456 20 88 42  
f: +49 7456 20 88 43

Japan: p: +81.45.565.9977  
f: +81.45.565.9938

### Support

Global: support@ampt.com

North America: p: +1 970.372.6951  
f: +1 970.225.0483

Europe: p: +49 7456 20 88 42  
f: +49 7456 20 88 43

Japan: p: +81.45.565.9977  
f: +81.45.565.9938



